

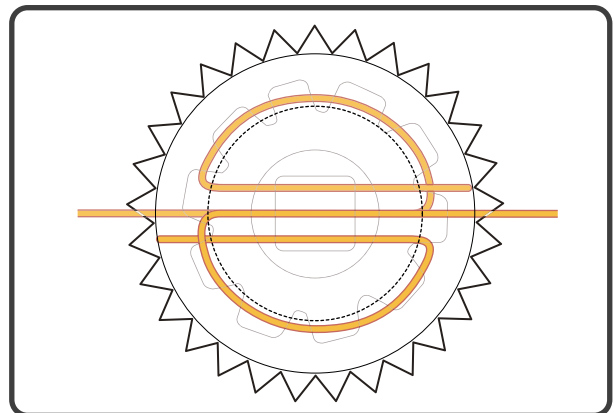

H2/H2 COILER LACE ATTACHMENT

(1 of 3)

HIGHPower
Reel Assembly

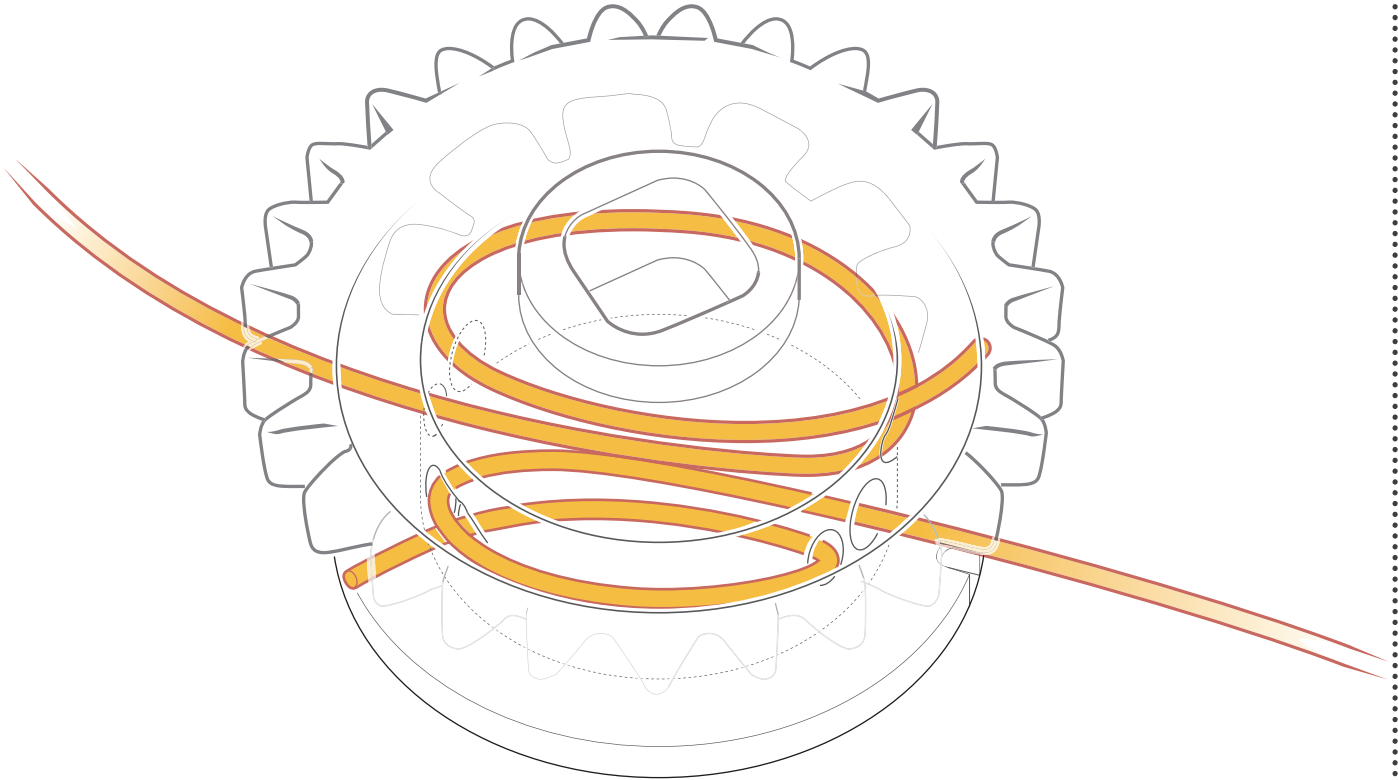

Continued on next page





H2/H2 COILER LACE ATTACHMENT

(2 of 3)

HIGHPower
Reel Assembly

1

LACE THROUGH WHITE HOLE

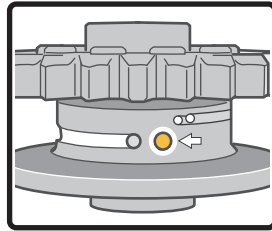
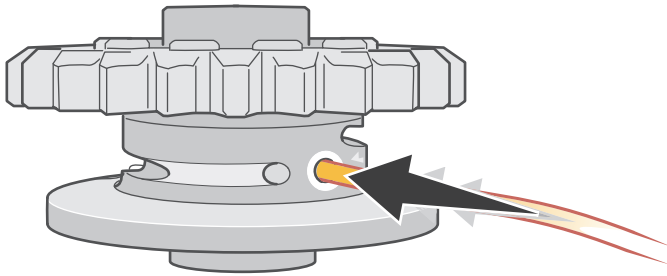

2

LOOP LACE AROUND GROOVE

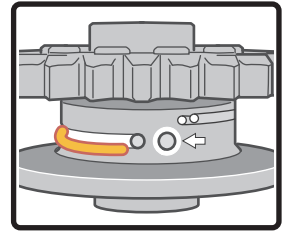
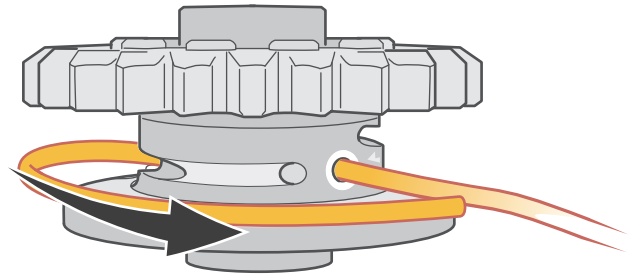

3

LACE THROUGH SMALL HOLE

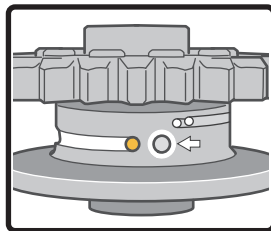
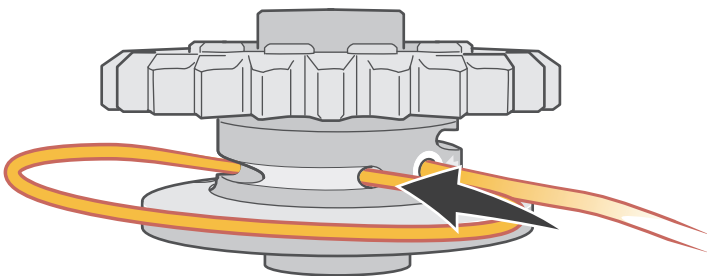

4

PUSH LACE OUT OTHER SIDE

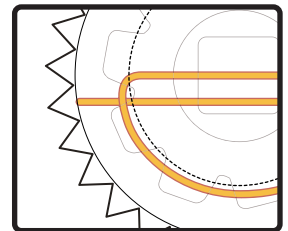
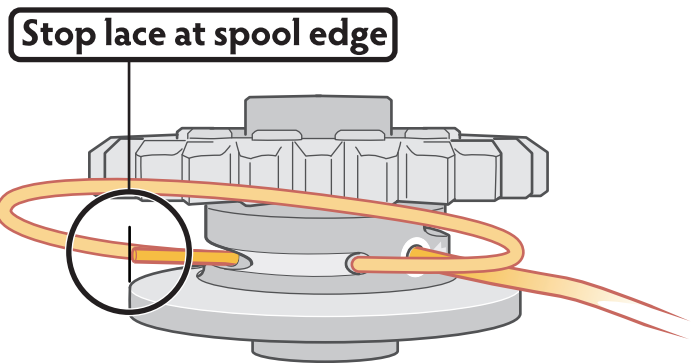

Continued on next page



H2/H2 COILER LACE ATTACHMENT

(3 of 3)

HIGHPower
Reel Assembly

5

**KEEP TAIL IN PLACE
ON SPOOL FLANGE**

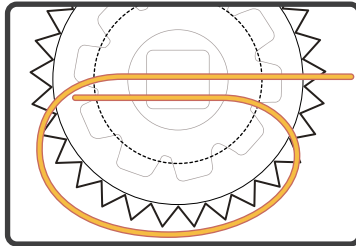
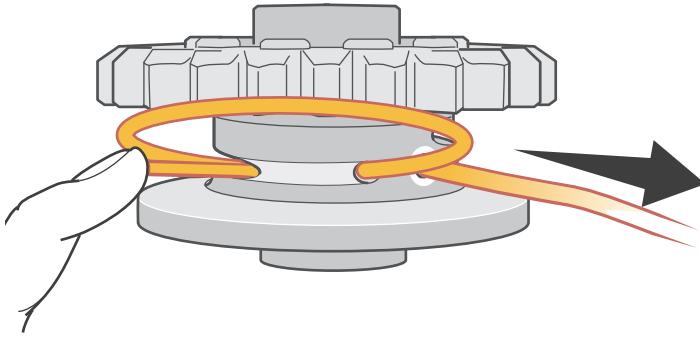

6

PULL LACE TO CLOSE LOOP

Stop lace before spool edge

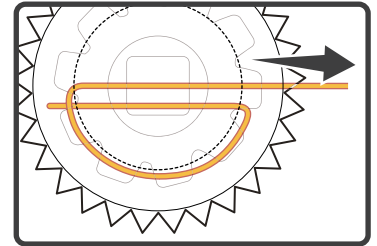
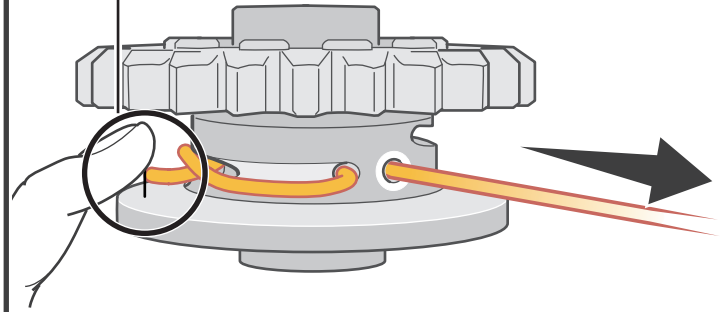

7

TAIL PINCHED TO SPOOL

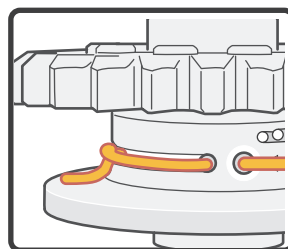
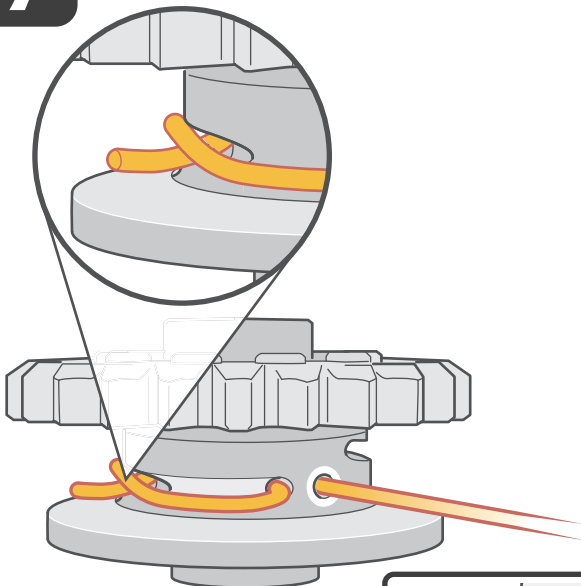

8

**REPEAT STEPS 1-6 FOR
THE OTHER SIDE**

Tail pinched to spool

